

Harvatek Surface Mount CHIP LEDs Data Sheet B3813BRG-H2C-00011K

Official Product	HT Part No. B3813BRG-H2C-00011K		
Tentative Product	*****	*****	*****
Specifications are subject to changes for improvement without advance notice. Proprietary data, drawings, company confidential all rights reserved.		07/03/2017	Version 1.5 Page 1/17

DISCLAIMER	3
LIFE SUPPORT POLICY	3
PRODUCT SPECIFICATIONS	4
ATTENTION: ELECTROSTATIC DISCHARGE (ESD) PROTECTION	4
LABEL SPECIFICATIONS	5
SPECIFICATIONS RANGE	6
PRODUCT FEATURES	8
ELECTRO-OPTICAL CHARACTERISTICS	8
PACKAGE OUTLINE DIMENSION AND RECOMMENDED SOLDERING PATTERN FOR REFLOW	
SOLDERING	8
ABSOLUTE MAXIMUM RATINGS	8
CHARACTERISTICS OF B3813BRG	9
PRECAUTION FOR USE	10
PACKAGING	11
TAPE DIMENSION	11
REEL DIMENSION	12
PACKING	12
DRY PACK	13
BAKING	13
PRECAUTIONS	13
REFLOW SOLDERING	14
REWORKING	14
CLEANING	14
CAUTIONS OF PICK AND PLACE	15
REVISE HISTORY	15

Official Product	HT Part No. B3813BRG-H2C-00011K		
Tentative Product	*****	*****	*****
Specifications are subject to changes for improvement without advance notice. Proprietary data, drawings, company confidential all rights reserved.		07/03/2017	Version 1.5 Page 2/17

DISCLAIMER

HARVATEK reserves the right to make changes without further notice to any products herein to improve reliability, function or design. HARVATEK does not assume any liability arising out of the application or use of any product or circuit described herein; neither does it convey any license under its patent rights, nor the rights of others.

Life Support Policy

HARVATEK's products are not authorized for use as critical components in life support devices or systems without the express written approval of the President of HARVATEK or HARVATEK INTERNATIONAL. As used herein:

1. Life support devices or systems are devices or systems which, (a) are intended for surgical implant into the body, or (b) support or sustain life, and (c) whose failure to perform when properly used in accordance with instructions for use provided in the labeling, can be reasonably expected to result in a significant injury of the user.
2. A critical component in any component of a life support device or system whose failure to perform can be reasonably expected to cause the failure of the life support device or system, or to affect its safety or effectiveness.

Official Product	HT Part No. B3813BRG-H2C-00011K		
Tentative Product	*****	*****	*****
Specifications are subject to changes for improvement without advance notice. Proprietary data, drawings, company confidential all rights reserved.	07/03/2017	Version 1.5	Page 3/17

Product Specifications

Item	Specification	Material	Quantity
Luminous Intensity(Iv)	71.5-360.0mcd R@4.8mA G @3.1mA B@2.0mA T _s = 25°C;Tolerance: ± 10%		
Chromaticity Coordinate	As page 6 & 7 & 8 R@4.8mA G @3.1mA B@2.0mA		
Vf	R : 1.6-2.6 V G : 2.0-4.0 V B : 2.0-4.0 V R@4.8mA G @3.1mA B@2.0mA T _S = 25°C ;Tolerance: ± 0.05V		
Ir	< 10 μA @ V _R = 5 V		
Resin	Clear	Epoxy	
Carrier tape	EIA 481-1A specs	Conductive black tape	
Reel	EIA 481-1A specs	Conductive black	
Label	HT standard	Paper	
Packing bag	220x240mm	Aluminum laminated bag/ no-zipper	One reel per bag
Carton	HT standard	Paper	Non-specified

Others:

Each immediate box consists of 5 reels. The 5 reels may not necessarily have the same lot number or the same bin combinations of Iv, λ_D and Vf. Each reel has a label identifying its specification; the immediate box consists of a product label as well.

Note :This is shipped test conditions

※Remarks: This product should be operated in forward bias. If a reverse voltage is continuously applied to the product, such operation can cause migration resulting in LED damage.

ATTENTION: Electrostatic Discharge (ESD) protection



The symbol to the left denotes that ESD precaution is needed. ESD protection for GaP and AlGaAs based chips is necessary even though they are relatively safe in the presence of low static-electric discharge. Parts built with AlInGaP, GaN, or/and InGaN based chips are **STATIC SENSITIVE devices**. ESD precaution must be taken during design and assembly.

If manual work or processing is needed, please ensure the device is adequately protected from ESD during the process.

Official Product	HT Part No. B3813BRG-H2C-00011K		
Tentative Product	*****	*****	
Specifications are subject to changes for improvement without advance notice. Proprietary data, drawings, company confidential all rights reserved.	07/03/2017	Version 1.5	Page 4/17

Label Specifications

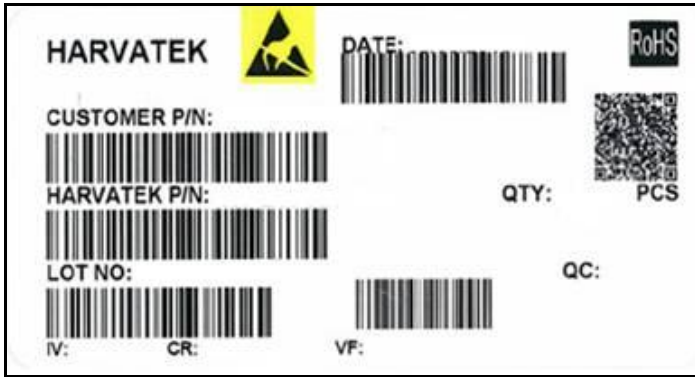

Harvatek P/N:

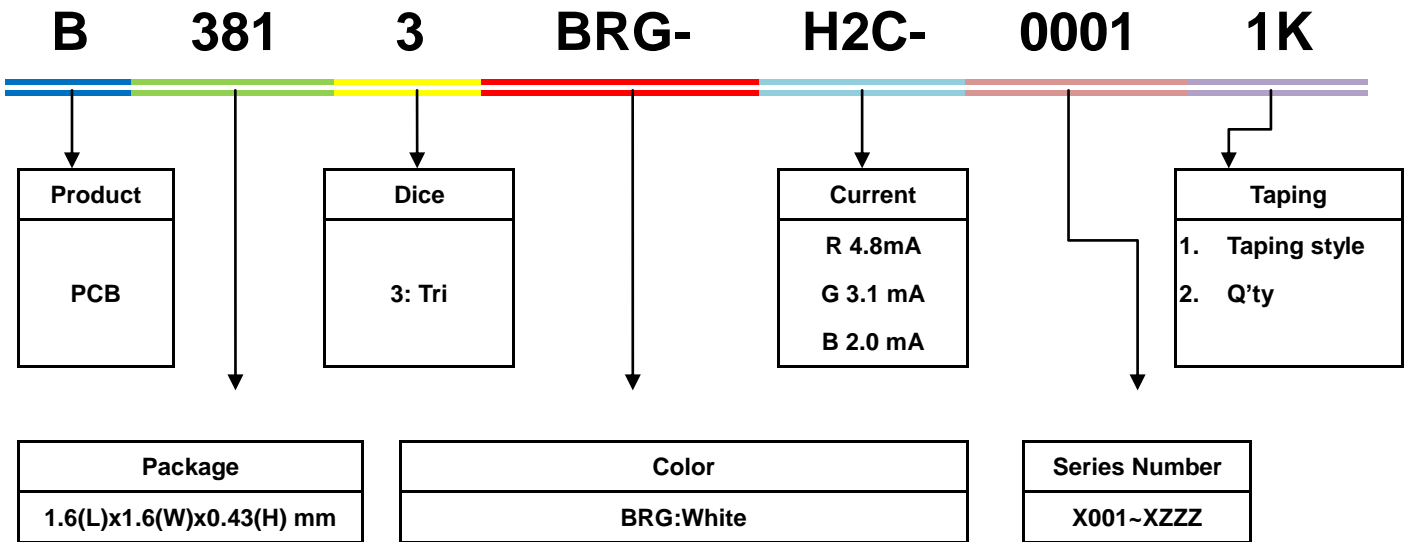

Lot No.:

1	2	3	4	5	6	7	8	9	10
E	1	A	1	A	2	2	L	1	2
Code 1 2		Code 3	Code 4	Code 5	Code 6	Code 7	Code 8	Code 9	Code 10
		Mfg. Year	Mfg. Month	Mfg. Date	Consecutive number		Special code		
Internal Tracing Code		2010-A 2011-B 2012-C 2013-D . .	1:Jan. 2:Feb. A:Oct. B:Nov. C:Dec.	1:A 2:B 3:C ... 26:Z 27:7 28:8 29:9 30:3 31:4	01~ZZ		000~ZZZ		

Official Product	HT Part No. B3813BRG-H2C-00011K		
Tentative Product	*****	*****	
Specifications are subject to changes for improvement without advance notice. Proprietary data, drawings, company confidential all rights reserved.	07/03/2017	Version 1.5	Page 5/17

Specifications Range

■ Luminous Intensity (Iv) Bin:

Color	Bin Code	Spec. Range
BRG	Q	71.5-112.5 mcd
	R	112.5-180.0 mcd
	S	180.0-285.0 mcd
	T	285.0-360.0 mcd

Note: It maintains a tolerance of $\pm 10\%$ on luminous intensity

■ Color Bin:

Color	PW05		PW06		PW07		PW08	
BRG	0.2570	0.2700	0.2820	0.2800	0.3070	0.2900	0.3320	0.3000
	0.2570	0.2950	0.2820	0.3050	0.3070	0.3150	0.3320	0.3250
	0.2820	0.3050	0.3070	0.3150	0.3320	0.3250	0.3570	0.3350
	0.2820	0.2800	0.3070	0.2900	0.3320	0.3000	0.3570	0.3100
	PW09		PW10		PW11		PW12	
	0.2570	0.2950	0.2820	0.3050	0.3070	0.3150	0.3320	0.3250
	0.2570	0.3200	0.2820	0.3300	0.3070	0.3400	0.3320	0.3500
	0.2820	0.3300	0.3070	0.3400	0.3320	0.3500	0.3570	0.3600
	0.2820	0.3050	0.3070	0.3150	0.3320	0.3250	0.3570	0.3350
	PW17		PW18		PW19		PW20	
	0.2570	0.3200	0.2820	0.3300	0.3070	0.3400	0.3320	0.3500
	0.2570	0.3450	0.2820	0.3550	0.3070	0.3650	0.3320	0.3750
	0.2820	0.3550	0.3070	0.3650	0.3320	0.3750	0.3570	0.3850
	0.2820	0.3300	0.3070	0.3400	0.3320	0.3500	0.3570	0.3600
	PW21		PW22		PW23		PW24	
	0.2570	0.3450	0.2820	0.3550	0.3070	0.3650	0.3320	0.3750
	0.2570	0.3700	0.2820	0.3800	0.3070	0.3900	0.3320	0.4000
	0.2820	0.3800	0.3070	0.3900	0.3320	0.4000	0.3570	0.4100
	0.2820	0.3550	0.3070	0.3650	0.3320	0.3750	0.3570	0.3850

Note: It maintains a tolerance of x,y ± 0.007

Official Product	HT Part No. B3813BRG-H2C-00011K		
Tentative Product	*****	*****	*****
Specifications are subject to changes for improvement without advance notice. Proprietary data, drawings, company confidential all rights reserved.		07/03/2017	Version 1.5 Page 6/17

Chromaticity Coordinate

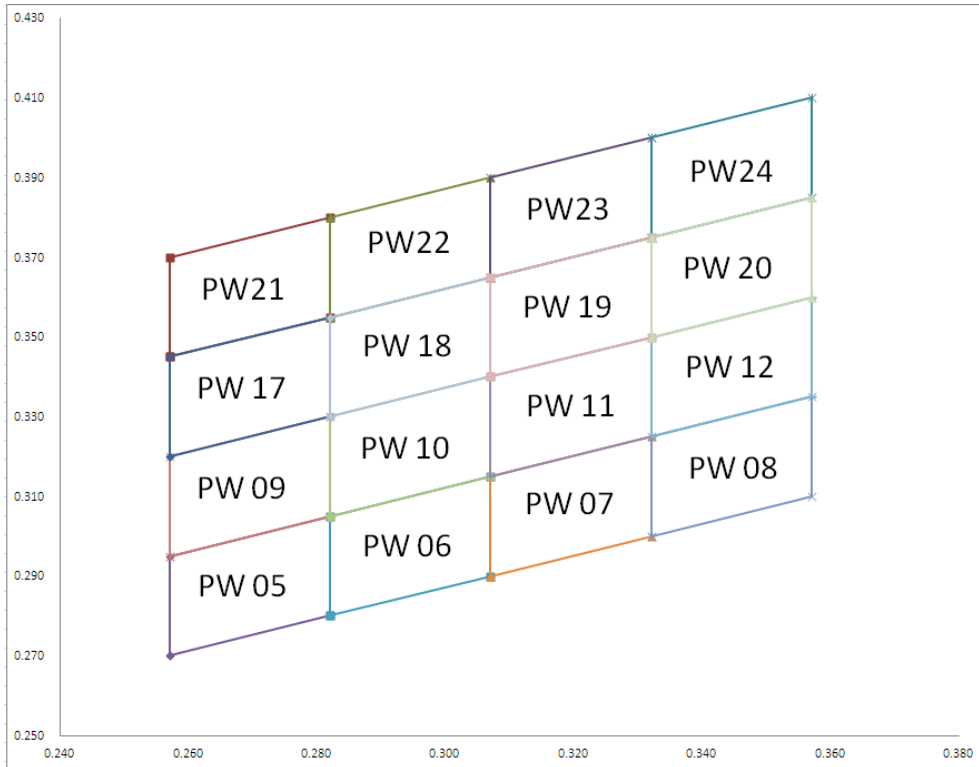

Forward Voltage (Vf) Bin:

Color	Bin Code	Spec. Range
B	F1L	2.0-4.0 V
R	E1A	1.6-2.6 V
G	F1L	2.0-4.0 V

Note: It maintains a tolerance of $\pm 0.05V$ on forward voltage measurements

Official Product	HT Part No. B3813BRG-H2C-00011K		
Tentative Product	*****	*****	*****
Specifications are subject to changes for improvement without advance notice. Proprietary data, drawings, company confidential all rights reserved.		07/03/2017	Version 1.5 Page 7/17

Product Features

Electro-Optical Characteristics

(T_{Soldering} , 25 °C)

Code for parts	Lighting Color	Material	Forward Voltage (V)		Chromaticity Coordinate X,Y	I _v (mcd) typ	I _F (mA) R:4.8 G:3.1 B:2.0	Viewing Angle $2\theta \frac{1}{2}$ X : 120 Y : 130
			typ.	max				
B3813BRG-H2	White	R:AlInGaP G:InGaN B:InGaN	R:1.9 G:2.8 B:2.8	R:2.6 G:4.0 B:4.0	X=0.3070,Y=0.3650	180		

Package Outline Dimension and Recommended Soldering Pattern for Reflow Soldering

(Unit:mm Tolerance: +/-0.1)

Outline Dim.	Soldering Pattern
Soldering terminals may shift in the x, y direction.	

Absolute Maximum Ratings

(T_{Soldering} ,25°C)

Series	P _D (mW)	I _F (mA)	I _{FP} (mA)*	T _{OP} (°C)	T _{ST} (°C)
Color	Power Dissipation	Forward Current	Pulse Forward Current	Operating Temperature	Storage Temperature
White	32.5	5	60	-40~+85	-40~+100

* Condition for I_{FP} is pulse of 1/10 duty and 0.1msec width

Official Product	HT Part No. B3813BRG-H2C-00011K		
Tentative Product	*****	*****	*****
Specifications are subject to changes for improvement without advance notice. Proprietary data, drawings, company confidential all rights reserved.	07/03/2017	Version 1.5	Page 8/17

Characteristics of B3813BRG

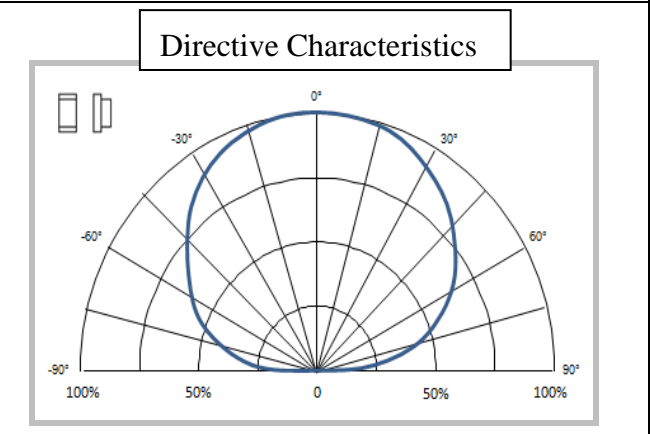
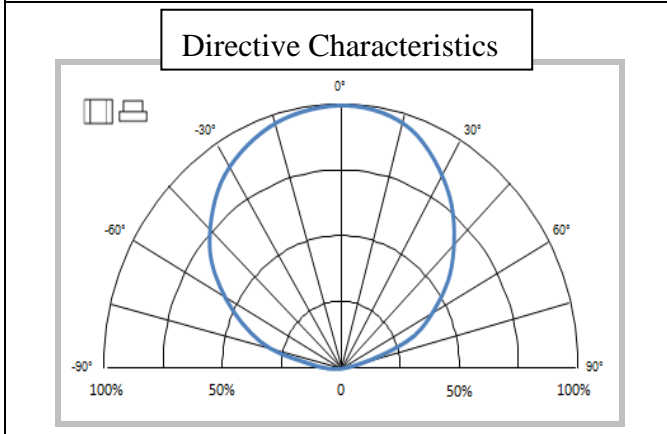
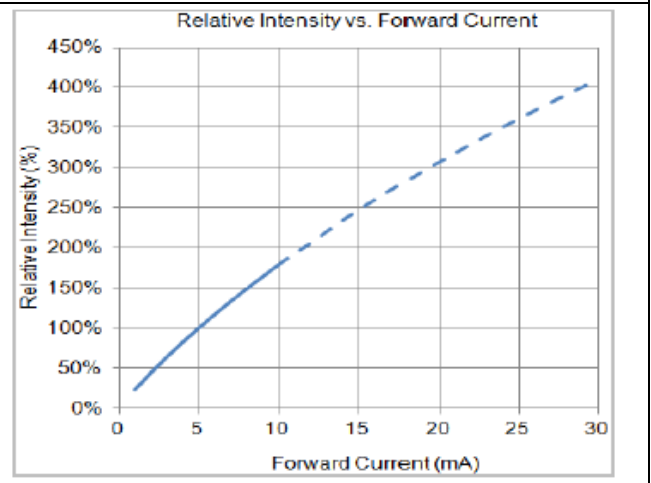
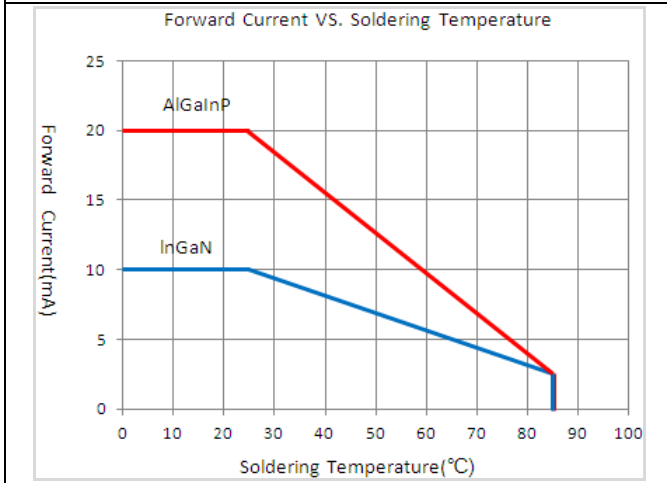
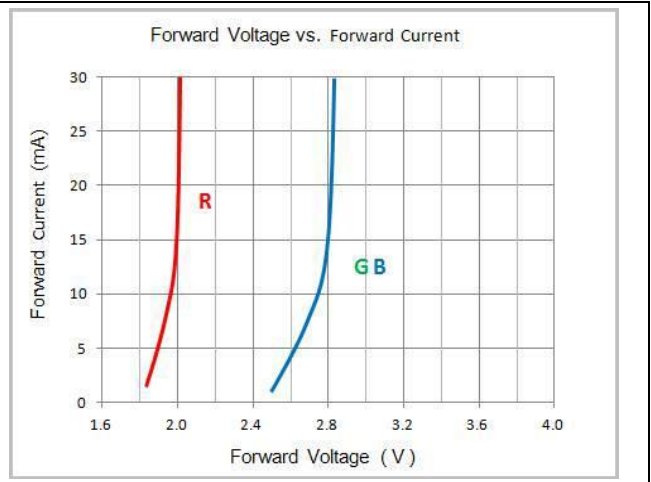
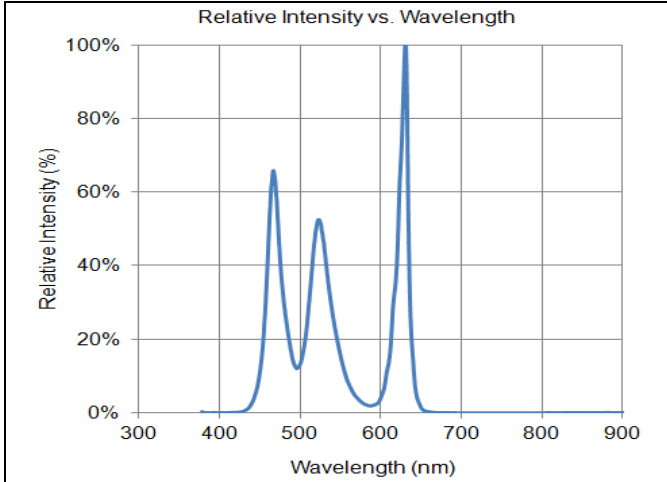

Official Product	HT Part No. B3813BRG-H2C-00011K		
Tentative Product	*****	*****	*****
Specifications are subject to changes for improvement without advance notice. Proprietary data, drawings, company confidential all rights reserved.	07/03/2017	Version 1.5	Page 9/17

Precaution for Use

1. The chips should not be used directly in any type of fluid such as water, oil, organic solvent, etc.
2. When the LEDs are illuminating, the maximum ambient temperature should be first considered before operation.
3. LEDs must be stored in a clean environment. A sealed container with a nitrogen atmosphere is necessary if the storage period is over 3 months after shipping.
4. The LEDs must be used within 4 weeks after unpacked. Unused products must be repacked in an anti-electrostatic package, folded to close any opening and then stored in a dry and cool space.
5. The appearance and specifications of the products may be modified for improvement without further notice.
6. The LEDs are sensitive to the static electricity and surge. It is strongly recommended to use a grounded wrist band and anti-electrostatic glove when handling the LEDs. If a voltage over the absolute maximum rating is applied to LEDs, it will damage LEDs. Damaged LEDs will show some abnormal characteristics such as remarkable increase of leak current, lower turn-on voltage and getting unlit at low current.

Official Product	HT Part No. B3813BRG-H2C-00011K		
Tentative Product	*****	*****	*****
Specifications are subject to changes for improvement without advance notice. Proprietary data, drawings, company confidential all rights reserved.		07/03/2017	Version 1.5 Page 10/17

Packaging Tape Dimension

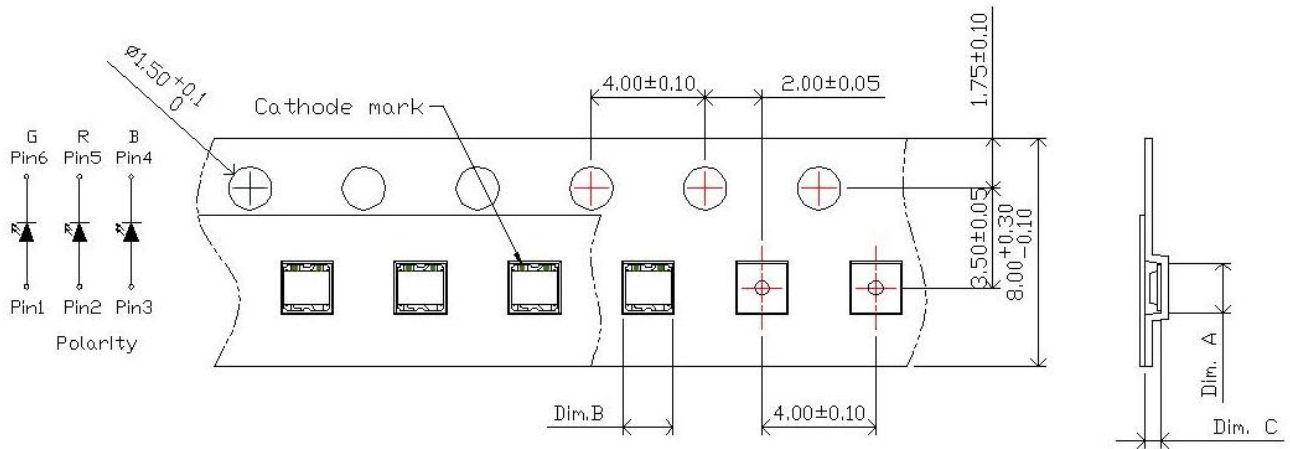

Dim. A	Dim. B	Dim. C	Q'ty/Reel
1.80 ± 0.10	1.70 ± 0.10	0.65 ± 0.10	0.5K

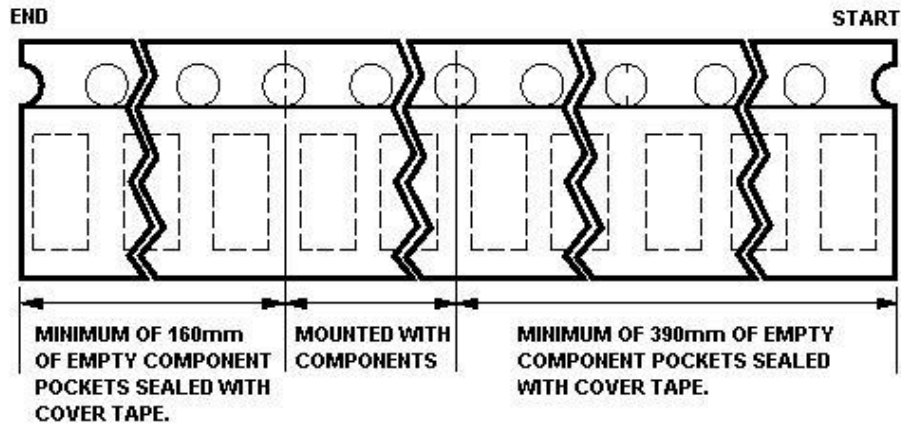

Official Product	HT Part No. B3813BRG-H2C-00011K		
Tentative Product	*****	*****	*****
Specifications are subject to changes for improvement without advance notice. Proprietary data, drawings, company confidential all rights reserved.		07/03/2017	Version 1.5 Page 11/17

Reel Dimension

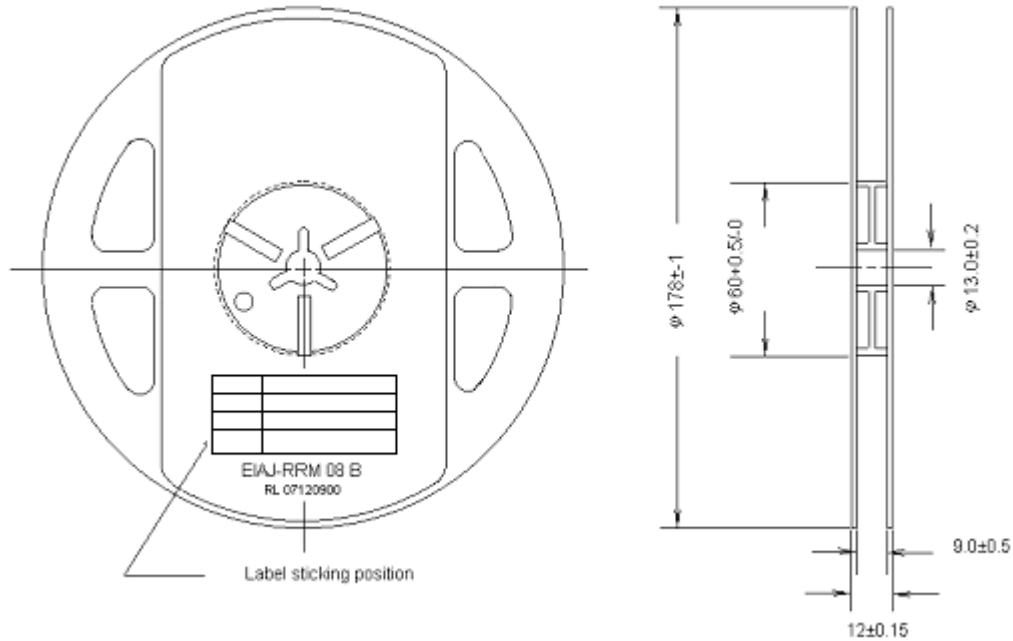

Packing

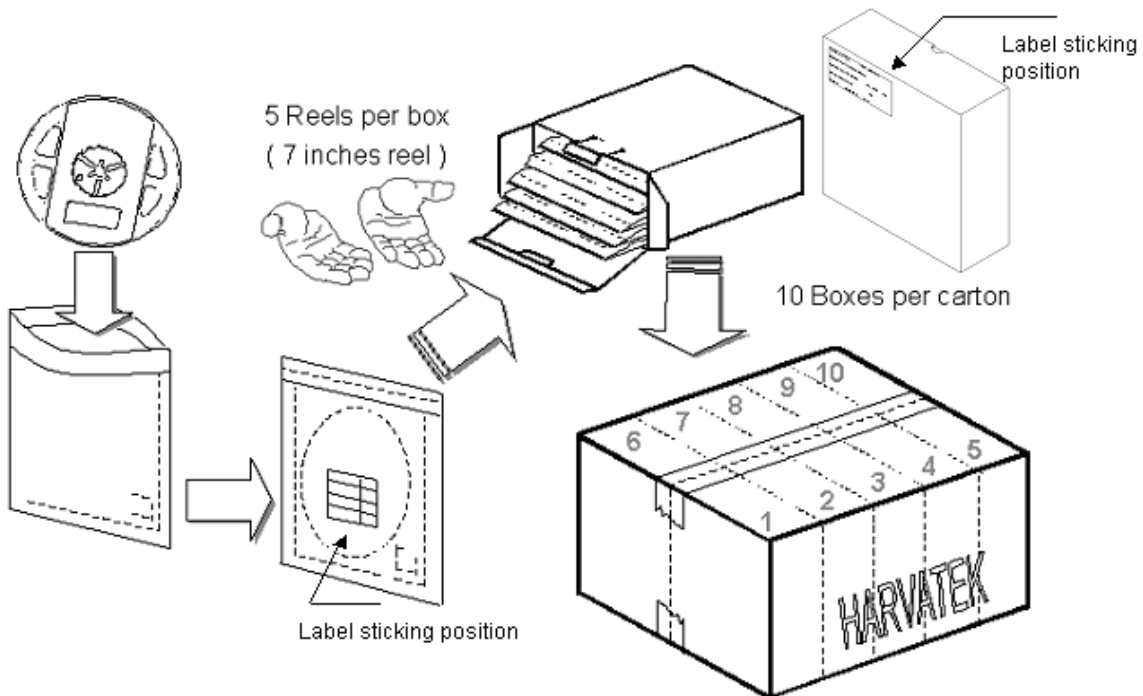

5 boxes per carton is available depending on shipment quantity.

Official Product	HT Part No. B3813BRG-H2C-00011K		
Tentative Product	*****	*****	*****
Specifications are subject to changes for improvement without advance notice. Proprietary data, drawings, company confidential all rights reserved.		07/03/2017	Version 1.5 Page 12/17

Dry Pack

All SMD optical devices are **MOISTURE SENSITIVE**. Avoid exposure to moisture at all times during transportation or storage. Every reel is packaged in a moisture protected anti-static bag. Each bag is properly sealed prior to shipment.

A humidity indicator will be included in the moisture protected anti-static bag prior to shipment.

The packaging sequence is as follows:

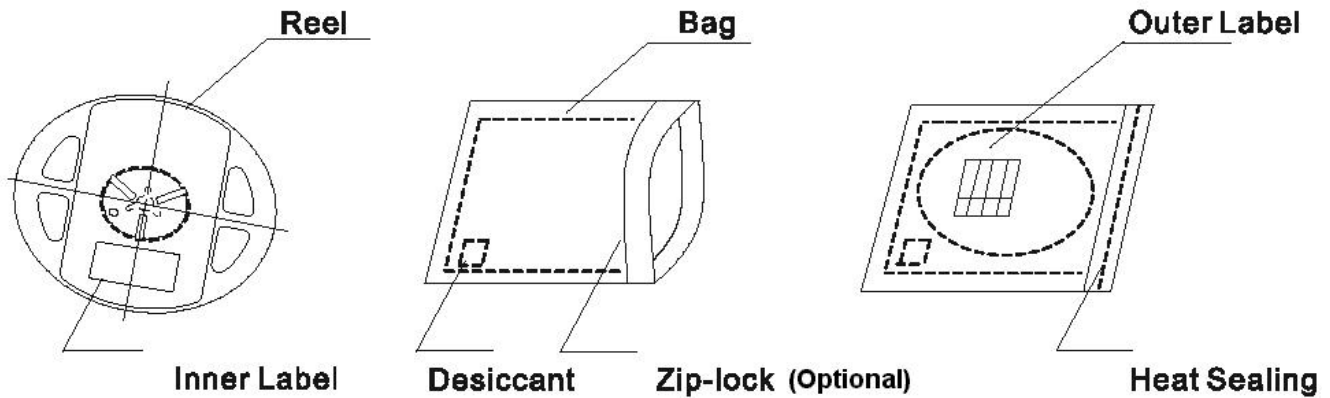

Baking

Baking before soldering is recommended when the package has been unsealed for 4 weeks.

The conditions are as followings:

1. 60±3°C x(12~24hrs)and<5%RH, taped reel type.
2. 100±3°C x(45min~1hr), bulk type.
3. 130±3°C x(15min~30min), bulk type.

Precautions

1. Avoid exposure to moisture at all times during transportation or storage.
2. Anti-Static precaution must be taken when handling GaN, InGaN, and AlInGaP products.
3. It is suggested to connect the unit with a current limiting resistor of the proper size. Avoid applying a reverse voltage beyond the specified limit.
4. Avoid operation beyond the limits as specified by the absolute maximum ratings.
5. Avoid direct contact with the surface through which the LED emits light.
6. If possible, assemble the unit in a clean room or dust-free environment.

Official Product	HT Part No. B3813BRG-H2C-00011K		
Tentative Product	*****	*****	*****
Specifications are subject to changes for improvement without advance notice. Proprietary data, drawings, company confidential all rights reserved.		07/03/2017	Version 1.5 Page 13/17

Reflow Soldering

Recommend soldering paste specifications:

1. Operating temp.: Above 220°C ,60 sec.
2. Peak temp.:260 °C Max.,10sec Max.
3. Reflow soldering should not be done more than two times.
4. Never attempt next process until the component is cooled down to room temperature after reflow.
5. The recommended reflow soldering profile (measured on the surface of the LED terminal) is as following:

Lead-free Solder Profile

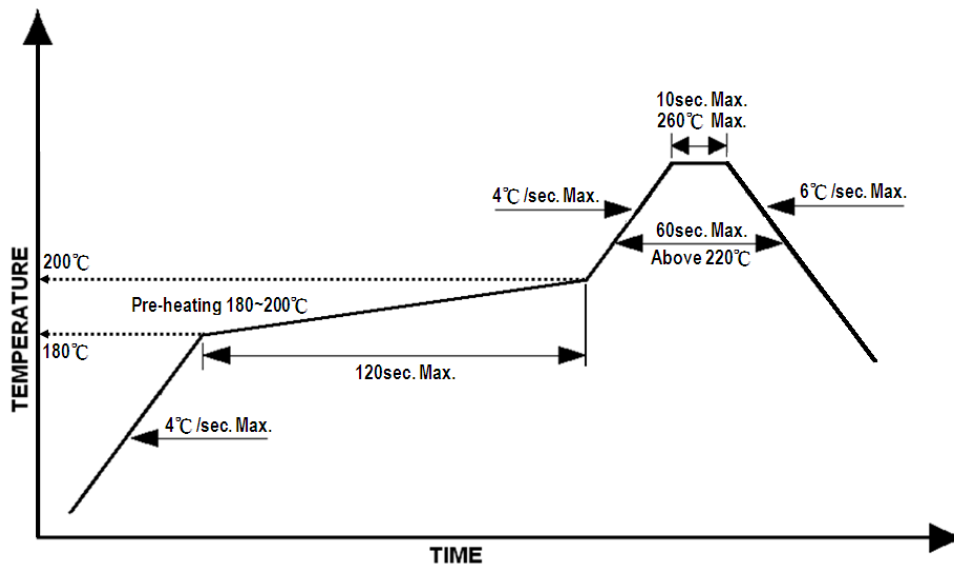

Reworking

- Rework should be completed within 5 seconds under 260 °C .
- The iron tip must not come in contact with the copper foil.
- Twin-head type is preferred.

Cleaning

Following are cleaning procedures after soldering:

- An alcohol-based solvent such as isopropyl alcohol (IPA) is recommended.
- Temperature x Time should be 50°C x 30sec. or <30°C x 3min
- Ultrasonic cleaning: < 15W/ bath; bath volume ≤ 1liter
- Curing: 100 °C max, <3min

Official Product	HT Part No. B3813BRG-H2C-00011K		
Tentative Product	*****	*****	*****
Specifications are subject to changes for improvement without advance notice. Proprietary data, drawings, company confidential all rights reserved.		07/03/2017	Version 1.5 Page 14/17

Cautions of Pick and Place

- Avoid stress on the resin at elevated temperature.
- Avoid rubbing or scraping the resin by any object.
- Electric-static may cause damage to the component. Please ensure that the equipment is properly grounded. Use of an ionizer fan is recommended.

Revise History

Rev.	Descriptions	Date	Page
1.0	-	03/27/2015	-
1.1	Renew form	11/12/2015	-
1.2	Update to official version	11/24/2015	-
1.3	Renew Forward Voltage VS Forward Current	04/22/2016	P11
1.4	Renew Form	08/26/2016	
1.5	Renew Form	07/03/2017	

Official Product	HT Part No. B3813BRG-H2C-00011K		
Tentative Product	*****	*****	*****
Specifications are subject to changes for improvement without advance notice. Proprietary data, drawings, company confidential all rights reserved.		07/03/2017	Version 1.5 Page 15/17